

Desigo™

Automation station

PXC4.E16



For the control of primary plants

- Compact automation station for HVAC and building control systems, freely programmable using graphical programming interface
- Communication BACnet/IP
- 2-port Ethernet switch for low-cost cabling
- 16 inputs/outputs: 12 universal inputs/outputs, 4 relay outputs
Extendable to 40 inputs/outputs via I/O modules TXM...
- Integration of Modbus data points via RTU and / or TCP
- WLAN interface for engineering and commissioning
- Operating voltage AC 24 V
- Mounted on standard rails or on the wall
- Plug-in screw terminal blocks

Functions

Automation station for HVAC and building control systems.

- System functions (alarming, scheduling, trending, access protection with individually definable user profiles and categories)
- Freely programmable (close resemblance to CEN standard 11312). All function blocks, available in libraries, can be graphically connected.
- Engineering and commissioning with the ABT Site Tool using graphical function charts
- BACnet communication, in compliance with the BACnet standard including B-BC profile (Rev. 1.15)
- Generic object viewer for device local data points via an embedded web-based interface
- Wireless connection for engineering and commissioning
- Cloud connectivity for remote access
- Integration of Modbus data points via RTU and/or TCP
- Direct connection of field devices

Type summary

Type	Order number	Description
PXC4.E16	S55375-C100	Compact automation station for BACnet/IP

Inputs/outputs

Total number of inputs/outputs (Onboard)	16
Number of universal inputs/outputs (UIO)	12
Number of relay outputs (DO)	4
Number of inputs/outputs (Onboard + TXM)	40
Number of Modbus data points TCP and/or RTU	40

UIO	Universal inputs/outputs support the following signal types: <ul style="list-style-type: none"> • Passive sensors LG-Ni 1000, 2x LG-Ni1000, Pt 1000 (*75, 385), NTC 10k, NTC 100k • Resistance sensors 1000 Ohm, 2500 Ohm, 2650 Ohm, 1000...1175 Ohm (for setpoint shift) • Active sensors DC 0 ... 10 V • Current measurement analog DC 0...20 mA or 4...20 mA, (inputs U1, U2, U7, U8) • Binary potential-free contacts for signaling functions • Counter to 25 Hz (electronic switch to 100 Hz) • Analog outputs DC 0...10 V
DO	Relay outputs for binary controls, changeover contact (NO, NC, pulse)

Equipment combinations

I/O modules TXM (Series D and later)

Description	Type	Data sheet
Digital input module 8 or 16 I/O points	TXM1.8D, TXM1.16D	CM2N8172
Universal module without / with local operation and LCD	TXM1.8U, TXM1.8U-ML	CM2N8173
Super universal module without / with local operation and LCD	TXM1.8X, TXM1.8X-ML	CM2N8174
Relay module without / with local operation	TXM1.6R, TXM1.6R-M	CM2N8175
Resistance measuring module (for Pt100 4-wire)	TXM1.8P	CM2N8176
Triac module	TXM1.8T	CM2N8179
Digital input and relay module	TXM1.4D3R	CM2N8188

PXC4 can power TXM extensions modules (for details see planning overview A6V11973797)

Design Control Point

Description	Type	Data sheet
BACnet touch panels with integrated Web server 7.0 " 10.1 " 15.6 "	PXM30.E PXM40.E PXM50.E	A6V11664137
Client Touch Panels with data storage in Web server PXG3.Wx00-1: 7.0 " 10.1 " 15.6 "	PXM30-1 PXM40-1 PXM50-1	A6V11664139
BACnet/IP Web server with standard functionality BACnet/IP Web server with extended functionality	PXG3.W100-1 PXG3.W200-1	A6V10808336

System controller

Description	Type	Data sheet
System controller to integrate Modbus and MS/TP devices	PXC5.E003	A6V11646020

Technical and mechanical design

The compact build allows for mounting the devices on a standard rail or a wall.

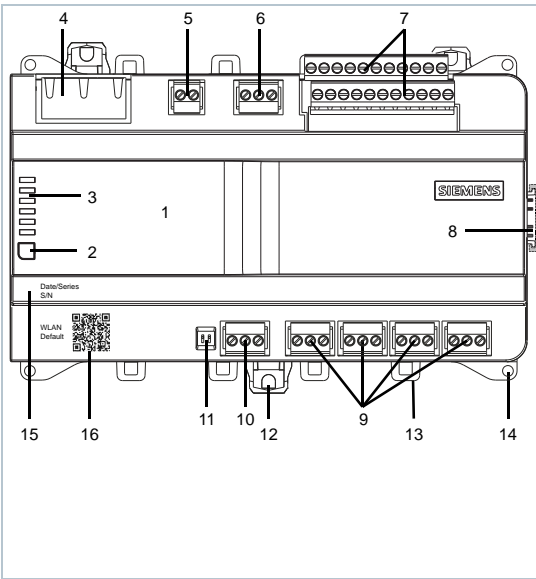
	4	2-port Ethernet switch with 2 LEDs per port for display purposes
	5	Plug-in terminal block with screw terminals KNX, PL-link, for future use
	6	Plug-in terminal block with screw terminals Power supply
	7	Plug-in terminal blocks with screw terminals Universal inputs/outputs, field device supply
	8	Connector for I/O modules TXM
	9	Plug-in terminal block with screw terminals Relay outputs
	10	Plug-in terminal block with screw terminals COM, Modbus RTU
	11	DIP switch for bus termination and polarization COM
	12	Slider for mounting on DIN rails
	13	Eyelets for cable ties
	14	Holes for wall mounting
	15	Date / Series and Serial number
	16	QR code for default WLAN access Description see Technical data
	1	Plastic housing
	2	Service button (identification in the network and WLAN on/off)
	3	LEDs for communication and state

LED displays

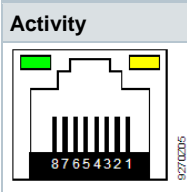
Activity	LED	Color	Activity	Function
	Ethernet 1/2	Green	Continuously ON Continuously OFF Flashing	Link active No connection Network traffic
		Yellow	Continuously ON Continuously OFF	Link 100 Link 10 Mbps
	RUN	Green	Continuously ON	Device operational



Activity	LED	Color	Activity	Function		
			Continuously OFF Flashing	Device not operational Start-up or program halted		
			Red	Continuously OFF Continuously ON Rapid flashing	OK HW or SW fault Firmware or application missing/corrupted	
				Blue	Continuously ON Continuously OFF	Connection to the cloud OK No connection to the cloud
			COM TX	Yellow	Flashing	Communication
			COM RX	Yellow	Continuously OFF	No communication to subsystem
			SVC	Red	Continuously OFF Flashing	OK Device is not configured
					Flashing per wink command	Identification of the device after receipt of wink command
	WLAN	Blue	Steady OFF	WLAN inactive		
			Steady ON	WLAN active and at least one WLAN client connected		
			Flashing	WLAN active and no WLAN client connected		
	Service button		Short press (< 1 s) Long press (> 3 s)	Identification in the network Enable / disable WLAN WLAN is disabled automatically after 10 min if no client is connected		
			As per description	Do the following to reset the device to factory state: <ol style="list-style-type: none"> 1. Power off the device. 2. Power on the device. 3. Wait until all LEDs light up and turn off again, then press the Service button. 4. Keep the Service button pressed until all LEDs light up, then release the button. All LEDs go off, the device restarts. 5. Wait until the device has fully started – unconfigured (green RUN LED and red SVC LED are flashing) 		

Product documentation

Related documents such as the environmental declarations, CE declarations, etc., can be downloaded from the following Internet address:

<https://siemens.com/bt/download>

Safety

 	<p>⚠ CAUTION</p>
	<p>National safety regulations</p> <p>Failure to comply with national safety regulations may result in personal injury and property damage.</p> <ul style="list-style-type: none"> • Observe national provisions and comply with the appropriate safety regulations. • This equipment is intended only for use in a restricted access area (lockable cabinet) • This equipment is not suitable for use in locations where children are likely to be present. • Conductors with a cross-section of 0.5 mm² (AWG24) or greater shall comply with the requirements of IEC 60332-1-2 and IEC 60332-1-3 or IEC TS 60695-11-21.

Mounting position and ambient temperature

The devices can be snapped onto standard rails or screwed onto a flat surface.
 Plug-in screw terminals connect power and interfaces.

Ambient temperature -5...50 °C (23...122 °F)	Ambient temperature -5...45 °C (23...113 °F)
<ul style="list-style-type: none"> • Wall, horizontal <ul style="list-style-type: none"> – From left to right – From right to left 	<ul style="list-style-type: none"> • Overhead • Wall, vertically <ul style="list-style-type: none"> – From top to bottom – From bottom to top • On a horizontal surface

	<p>⚠ CAUTION</p>
	<p>Risk of overheating for failure to comply with ambient temperature</p> <p>Burning and damage to the device</p> <ul style="list-style-type: none"> • Ensure sufficient ventilation to comply with the permissible ambient temperature within the panel or installation box. The temperature must be at least 10 K (18° F) lower outside the installation box.

Installation

	<p>⚠ WARNING</p>
	<p>No internal line protection for supply lines to external consumers</p> <p>Risk of fire and injury due to short-circuits!</p> <ul style="list-style-type: none"> • Adapt the wire cross sections as per local regulations to the rated value of the installed fuse.

	<p>⚠ WARNING</p>
	<p>The relay outputs may be connected to mains voltage</p> <p>Risk of electrical shock!</p> <ul style="list-style-type: none"> • Use terminal covers or install the device in a lockable cabinet.

Disposal



The device is considered an electronic device for disposal in accordance with the European Guidelines and may not be disposed of as domestic garbage.

- Dispose of the device through channels provided for this purpose.
- Comply with all local and currently applicable laws and regulations.

Technical data

Power supply

Operating voltage (24 V~, \perp , ⏚)	AC 24 V -15 / +20 % (SELV / PELV) or AC 24 V Class 2 (US) 48...63 Hz
Functional ground (US) Functional earth ⏚	The terminal for the functional ground must be connected on the installation side with the building grounding system (PE).
Screw terminals for wire cross sections up to	Max. 2.5 mm ² (14 AWG)
Internal fusing	4 A irreversible / non-replaceable
External supply line fusing (EU)	Non-renewable fuse max. 10 A slow-blow or circuit breaker max. 13 A Tripping characteristic B, C, D per EN 60898 or Power supply with current limitation of max. 10 A

Power consumption (for transformer planning)

Base load (without loading by I/O modules TXM and field devices)	10 VA / 0.4 A
Field device supply V+ (DC 24 V, 100 mA) (terminals 8 and 19)	5 VA / 0.2 A
Field device supply V- (AC 24 V, 2 A) (terminals 18 and 29)	48 VA / 2 A
I/O modules TXM supply	15 VA / 0.6 A

Function data

Hardware information	
Processor	Texas Instruments AM335x, 300 MHz
Storage	128 MByte SDRAM (DDR3) 512 MByte NAND Flash

Data backup in the event of power failure	
Energy reserve (supercap) to support real-time clock (7 days).	
Data available if stored to flash memory. Occurs every 5 minutes.	

Interfaces

Screw terminals, plug-in	
Cu-wire or Cu-strand with wire end sleeve	1 x 0.6 mm Ø to 2.5 mm ² (22 to 14 AWG) or 2 x 0.6 mm Ø to 1.0 mm ² (22 to 18 AWG)
Cu-strand without wire end sleeve	1 x 0.6 mm Ø to 2.5 mm ² (22 to 14 AWG) or 2 x 0.6 mm Ø to 1.5 mm ² (22 to 16 AWG)
Stripping length	6...7.5 mm (0.24...0.29 in)
Screwdriver	Slot screws, screwdriver size 1
Max. tightening torque	0.6 Nm (0.44 lb ft)

Ethernet interface	
Plug	2 x RJ45, shielded
Interface type	10Base-T / 100Base-TX, IEEE 802.3 compatible
Bit rate	10/100 Mbps, autosensing
Protocol	BACnet on UDP/IP and HTTPS on TCP/IP
Cabling (in-house cabling only), cable type	10 Mbps: Min. CAT3, shielded cable is recommended 100 Mbps: Min. CAT5, shielded cable is recommended
Cable length	Max. 100 m (330 ft)

Modbus RTU interface	
Interface type	EIA-485, electrically isolated
Baud rate	1200, 2400, 4800, 9600, 19200, 38400, 57600, 115200 (depending on the configuration)
Internal bus termination	120 Ohm, switchable with DIP switch
Internal bus polarization	270 Ohm pull-up/pull-down resistances, switchable with DIP switch
Cabling (in-house cabling only)	3-wire cable
Cable length	Max. 1000 m (3300 ft)
Protection	Short-circuit proof Protection against faulty wiring with AC 24 V

WLAN interface	
Interface type	Wireless access point
Supported standards	IEEE 802.11b/g/n
Frequency band	2.4...2.462 GHz
WLAN channels	1...11
Maximum radio-frequency power	16.4 dBm
Distance (unobstructed field)	Min. 5 m (16 ft)
Device pairing	Activation / Deactivation with service button Automatic switch off after 10 minutes if no WLAN-client is connected. Optionally, for cyber security reasons, the WLAN can be permanently disabled via configuration.
<p>Default SSID and WLAN password: Scan the QR code. It will show something like WiFi:S:PXC4.E16_0000550;T:WPA;P:1400052738;; Then SSID = PXC4.E16_0000550 and password = 1400052738 Determine manually: Use the information from the Date/Series/SN block It will show something like: Date/Series: 20190423A0000550 S/N: 1400052738 SSID = <ASN>_<Running number after the series letter> and password = <S/N></p>	

I/O modules TXM interface	
Nominal voltage	DC 24 V
Power supply for I/O modules TXM	Max. 300 mA

I/O modules TXM interface	
Parallel switchable with 24VDC Supply TXS1.12F4	For details, see: TX-I/O engineering and installation, CM110562
Protection	Short-circuit proof
Connector for I/O modules TXM on the side: No protection against faulty wiring with AC 24 V	No electrical protection. Use the cover

Inputs

12 universal inputs U1...U12 with the following functions

Temperature measurement, analog		
Type	Range (over range)	Resolution
AI NTC10K	-40...115 °C (-52.5...155 °C) -48...239 °F (-62.5...311 °F)	10 mK (25 °C) 0.018 °F
AI NTC100K	-40...125 °C (-52.5...155 °C) -48...257 °F (-62.5...311 °F)	
AI PT1K 385 (EU) *)	-50...600 °C (-52.5...610 °C) -58...1112 °F (-62.5...1130 °F)	20 mK 0.036 °F
AI PT1K 375 (NA) *)	-50...180 °C (-52.5...185 °C) -58...356 °F (-62.5...365 °F)	10 mK 0.018 °F
AI (LG-)Ni1000 *)		
AI 2x (LG-)Ni1000 *)		

Resistance sensor, analog		
Type	Range (over range)	Resolution
AI 1000 Ohm *)	0...1000 Ω (0...1050 Ω)	0.1 Ω
AI 2500 Ohm *)	0...2500 Ω (0...2650 Ω)	0.1 Ω
AI Pt1000 *)	0...2500 Ω (0...2650 Ω)	0.1 Ω
AI 1000-1175 Ohm *) for setpoint shift	1000...1175 Ω (900...1295 Ω)	0.1 Ω

*) A fixed value of 1 Ω is calibrated to correct line resistance.

Voltage measurement, analog		
Type	Range (over range)	Resolution
AI 0...10 V	0...10 V (-1.5...11.5 V)	1 mV
AI 0...10 V standard	0...100% (-10...110%)	0.01%
Open connection: Negative voltage -1.5 V (line failure detection)		



Current measurement, analog (only inputs U1, U2, U7, U8)			
Type	Range (over range)	Resolution	Load
AI 4-20 mA	4...20 mA (1.6...22.4 mA)	1 µA	Min. 490 Ω
AI 0-20 mA	0...20 mA (-3...23 mA)	1 µA	Min. 490 Ω

Digital input			
Contact query voltage		21.5...25 V	
Contact query current		1 mA; 6 mA initial current	
Contact resistance for closed contacts		Max. 200 Ω	
Contact resistance for open contacts		Min. 50 kΩ	
Counter memory (counter inputs)		0 ... 4.3 x 10 ⁹ (32-bit counter)	
	Min. closing/operating time [ms] including bounces	Of which Max. bounce time [ms]	Max. counter frequency (symmetrical)
BI NO / BI NC	60	20	

Digital input			
BI Pulse NO	30	10	
CI Mech (25Hz)	20	10	25 Hz
CI EI (100Hz)	5	0	100 Hz

Outputs

Analog output			
Type	Range (over range)	Resolution	Output current
AO 0-10 V	0...10 V (-0.05...10.6 V)	1 mV	Max. 1 mA
AO 0-10 V standard	0...100% 0% = 0 V, 100% = 10 V (-0.05...10.6 V)	0.01 %	Max. 1 mA

Relay output (outputs DO1...DO4)  	
External supply line fusing Non-renewable fuse Circuit breakers	Max. 10 A, slow Max. 13 A, characteristic B, C, D as per EN 60898
Switching voltage AC/DC	Max. AC 250 V / DC 30 V Min. AC/DC 12 V
Current load AC	NO contact: Max. 4 A resistive, 3 A inductive (cos phi 0.6) NC contact: max. 2 A resistive, 1.5 A inductive (cos phi 0,6) Min. 1 mA at AC 250 V Min. 10 mA at AC 12 V
Current load DC	NO contact: Max. 3 A resistive at DC 30 V NC contact: Max. 1 A resistive at DC 30 V Min. 10 mA resistive at DC 12 V
Switch-on current	NO contact: Max. 10 A (1 s) NC contact: Max. 3 A (1 s)
Response/release time	7 ms / 3 ms typical
Contact life at AC 250 V (reference values) At 0.3 A resistive NO contact at 3 A resistive NC contact at 2 A resistive Reduction fact at ind. load (cos phi = 0.6)	5 x 10 ⁵ switchings 1 x 10 ⁵ switchings 1 x 10 ⁵ switchings 0.6
Insulating strength between relay contacts and system electronics (reinforced insulation).	AC 3750 V, as per EN 60730-1

Field device supply (Onboard)	
AC 24 V (terminal V~)	Max. 2 A, short-circuit proof *)
DC 24 V (terminal V+)	Max. 100 mA, short-circuit proof, protected against incorrect wiring with AC 24 V

Field device supply (I/O modules TXM)	
AC 24 V (terminal V~ on the I/O modules TXM)	Max. 2 A, short-circuit proof *)

*) Sum total onboard V~ and TXM bus V~ max. 2 A

Ambient conditions and protection classification	
Classification as per EN 60730	Type 1
Automatic action	Class A
Control function	2
Degree of pollution	III
Overvoltage category	
Design	Suitable for use in protection class I or II systems
Degree of protection of housing to EN 60529	
Front parts in DIN cut-out	IP30
Terminal part	IP20
Climatic ambient conditions	
<ul style="list-style-type: none"> Storage / Transport (packaged for transport) as per IEC EN 60721-3-2 Operation as per IEC/EN 60721-3-3 	<ul style="list-style-type: none"> Class 1K22 / 2K21 Temperature -25...70 °C (-13...158 °F) Air humidity 5...95 % (non-condensing) Class 3K22 Temperature -5...50 °C (23...122 °F) <i>(for details see chapter Mounting)</i> Air humidity 5...95 % (non-condensing)
Mechanical ambient conditions	
<ul style="list-style-type: none"> Transport per IEC/EN 60721-3-2 Operation as per IEC/EN 60721-3-3 	<ul style="list-style-type: none"> Class 2M11 Class 3M11

Standards, directives and approvals	
Product standard	EN 60730-1
Product family standard	EN 50491-x
Electromagnetic compatibility (EMC)	For residential, commercial, and industrial environments
EU conformity (CE)	See CE declaration ¹⁾
EAC compliance	Eurasian compliance
RCM conformity	See RCM declaration ¹⁾
UL/cUL approbation (US / Canada)	UL916; http://ul.com/database
CSA certification	C22.2, http://csagroup.org/services-industries/product-listing
FCC	CFR 47 Part 15 Class B
BACnet.	B-BC
Environmental compatibility ¹⁾	The product environmental declaration ¹⁾ contains data on environmentally compatible product design and assessments (RoHS compliance, materials composition, packaging, environmental benefit, disposal).

¹⁾ Documents can be downloaded at <http://siemens.com/bt/download>.

FCC Statement

This equipment has been tested and found to comply with the limits for a Class B digital device, pursuant to part 15 of the FCC Rules. These limits are designed to provide reasonable protection against harmful interference in a residential installation. This equipment generates, uses and can radiate radio frequency energy and, if not installed and used in accordance with the instructions, may cause harmful interference to radio communications. However, there is no guarantee that interference will not occur in a particular installation. If this equipment does cause harmful interference to radio or television reception, which can be determined by turning the equipment off and on, the user is encouraged to try to correct the interference by one or more of the following measures:

- Reorient or relocate the receiving antenna.
- Increase the separation between the equipment and receiver.

- Connect the equipment into an outlet on a circuit different from that to which the receiver is connected.
- Consult the dealer or an experienced radio/TV technician for help.

This device complies with Part 15 of the FCC rules. Operation is subject to the following two conditions:

1. This device may not cause harmful interference, and
2. this device must accept any interference received, including interference that may cause undesired operation

FCC Caution: Changes or modifications not expressly approved by Siemens Switzerland Ltd. could void the user's authority to operate the equipment. United States representative <https://new.siemens.com/us/en/products/buildingtechnologies/home.html>

Industry Canada statement

This device complies with ISED's licence-exempt RSSs. Operation is subject to the following two conditions:

1. This device may not cause interference, and
2. this device must accept any interference received, including interference that may cause undesired operation.

Radio frequency radiation exposure Information for USA and Canada

This equipment complies with FCC and IC radiation exposure limits set forth for an uncontrolled environment.

This equipment should be installed and operated with a minimum distance of 20 cm (8 in) between the radiator and your body.

This transmitter must not be co-located or operated in conjunction with any other antenna or transmitter.

Housing

Color top/bottom	RAL 7035 (light grey) / RAL 7016 (anthracite grey)
Dimensions	per DIN 43880, see dimensions
Weight without/with packaging	483 g / 553 g

Connection terminals

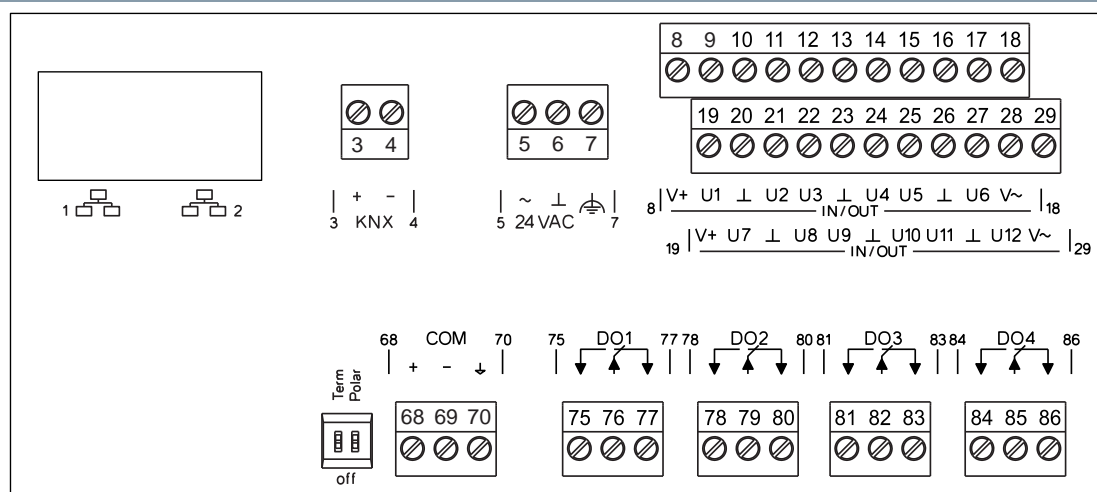

Terminal	Symbol	Description	Module	Channel
1, 2		2 x RJ45 interface for Ethernet with switch		
3, 4	KNX	KNX PL-Link (for future use)		
5, 6	24 V ~,	Operating voltage AC 24 V		
7		Functional ground (must be connected on the installation side with		

		the building grounding system (PE).		
8 to 29	Ux	Universal inputs/outputs	61	1...12
	⊥	Measuring ground for Ux		
8, 19	V+	DC 24 V power for field devices 2.4 W / <100 mA		
18, 29	V~	AC 24 V power for field devices 48 VA / 2 A		
68, 69, 70	COM	Interface EIA-485 (Modbus RTU)		
Term	on, off	Switch for bus termination		
Polar	on, off	Switch for polarization		
75 to 86	DOx	Relay outputs	11	1...4

Wiring lines for field devices

Wiring length max. 300 m (1,000 ft), CU wire or CU strand.

Cross-section depending on the signal

30 m (100 ft) applies for signal types AI NTC10K and AI NTC100K or 80 m (260 ft) with shielding

Examples of connection diagrams for universal inputs/outputs

Digital inputs

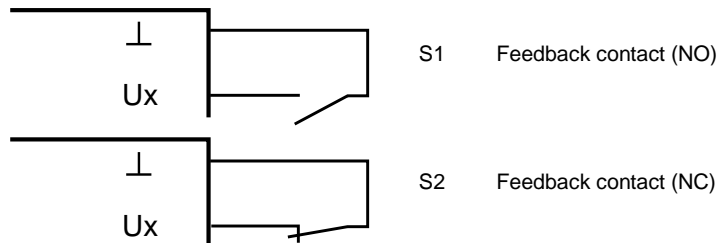

Count inputs:

Counter inputs, that count faster than 1 Hz and are laid with more than 10 meters using analog inputs in the same cable duct, must be shielded.

Analog inputs

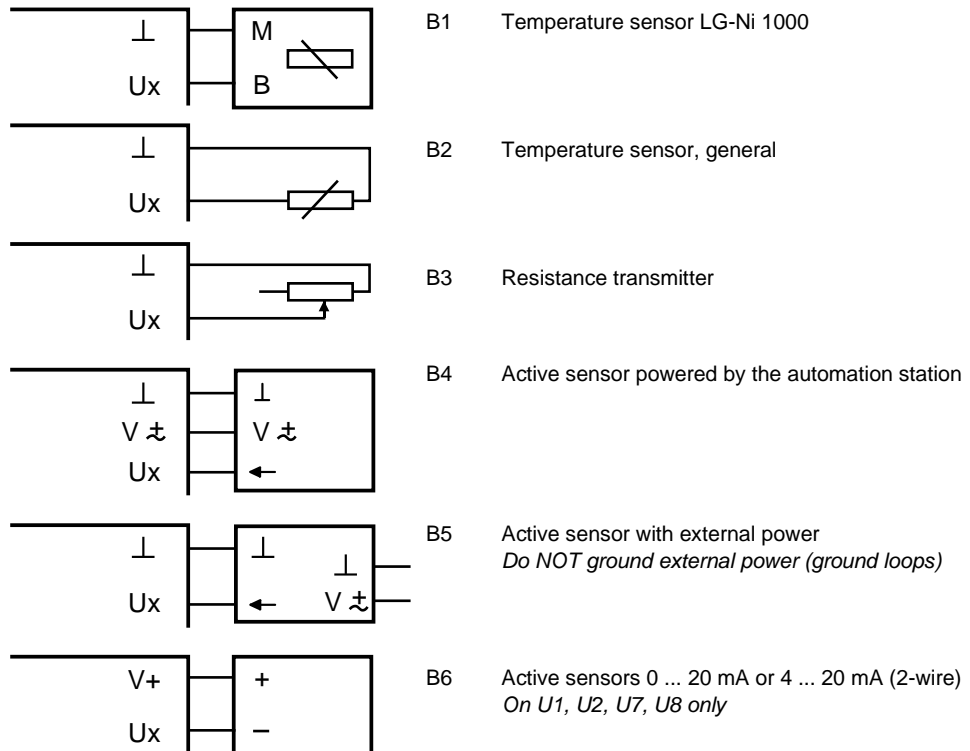

Analog outputs

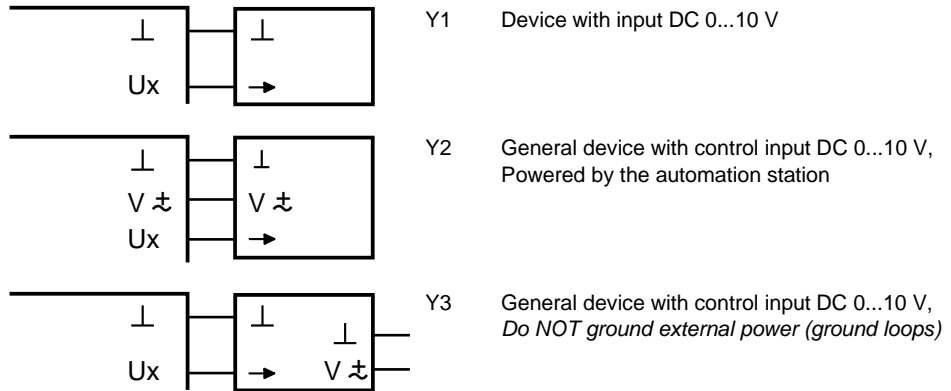

Warranty

Technical data on specific applications are valid only together with Siemens products listed under "Equipment combinations". Siemens rejects any and all warranties in the event that third-party products are used.

Dimensions

All dimensions in mm and inches.

PXC4.E16

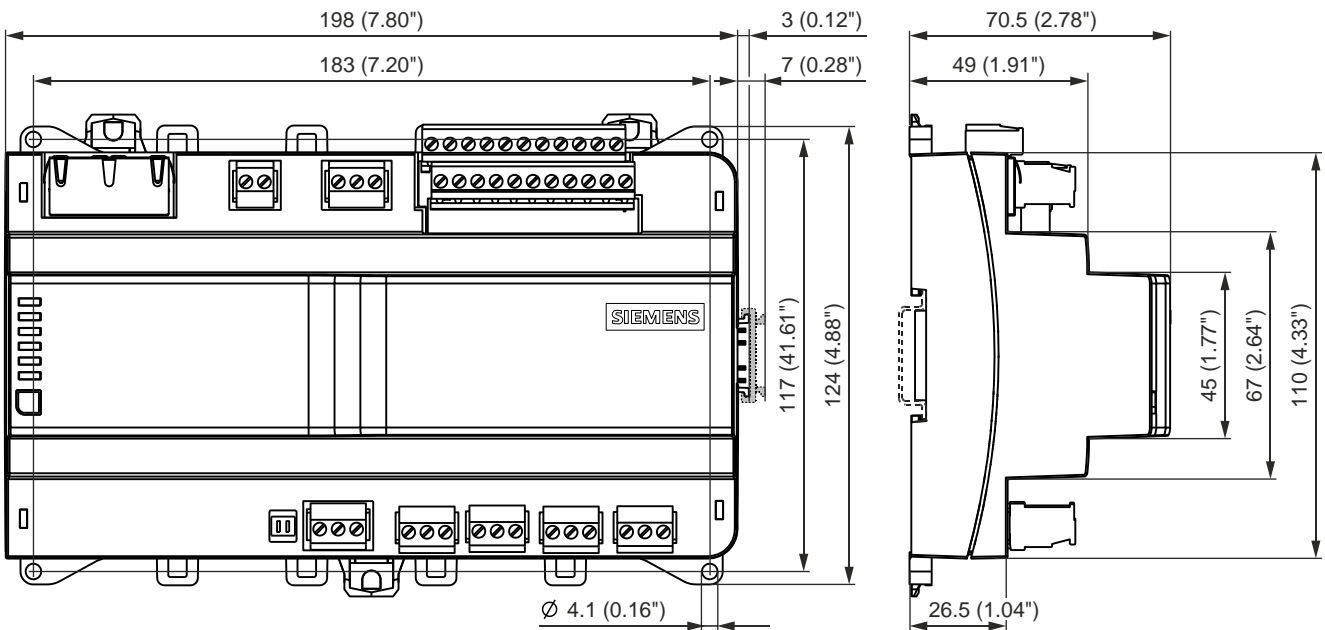

PXC4.E16 with I/O modules TXM

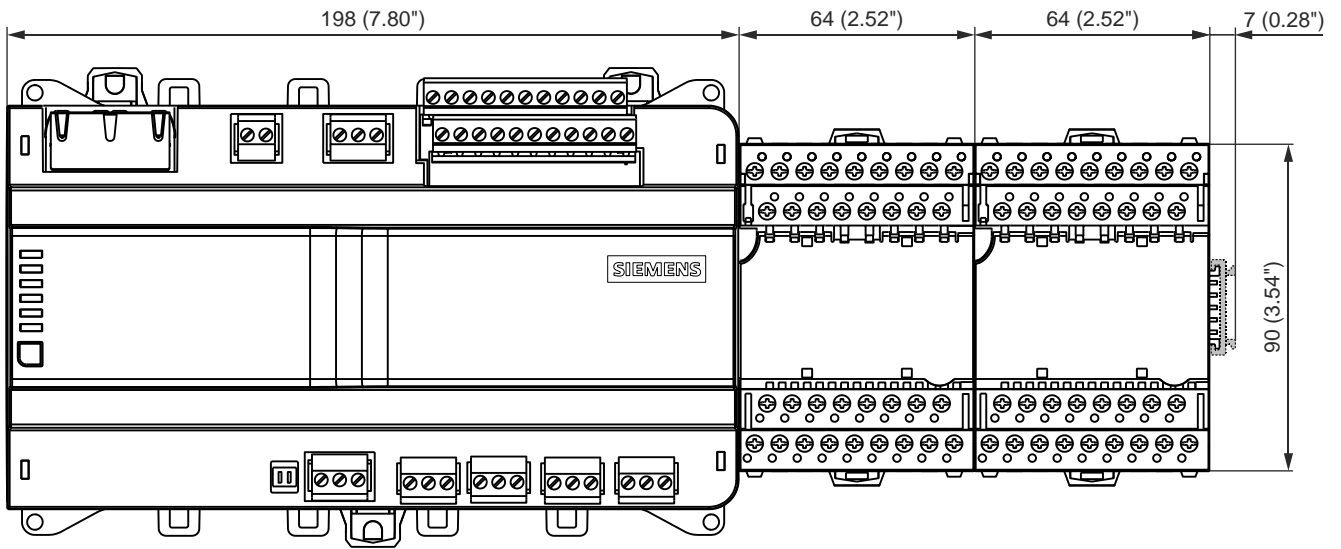

Issued by
Siemens Switzerland Ltd
Smart Infrastructure
Global Headquarters
Theilerstrasse 1a
CH-6300 Zug
Tel. +41 58 724 2424
www.siemens.com/buildingtechnologies

© Siemens Switzerland Ltd, 2020
Technical specifications and availability subject to change without notice.